

Derby

Market entry display



Derby Gelato case is best suited for patrons looking to add gelato source of revenue to their menu or wholesalers looking to deliver professional grade products to the market... With a large Evaporator, tilted deck and storage capacity this economical showcase does the rest



Discover the Art of Display...

DERBY

Gelato Showcase

DERBY GELATO - 26 3/8" DEEP

DERBY PLUS GELATO - 32 1/2" DEEP

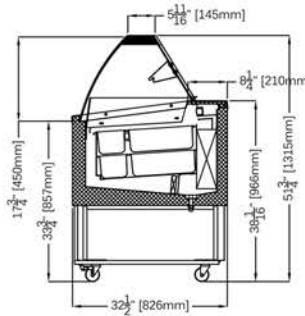
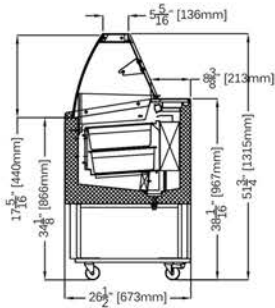

**DERBY GELATO
DG7**

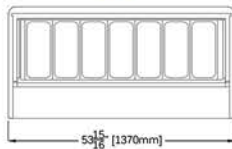

DERBY PLUS GELATO OPTIONAL PAN CONFIGURATIONS:

DPG8

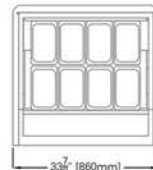

4 LITER

DPG10

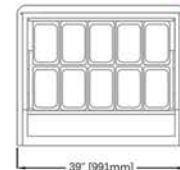

4 LITER

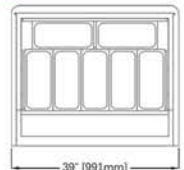

5 LITER

STANDARD FEATURES

- Hermetic Compressor: high capacity refrigeration low consumption and low noise levels
- Automatic defrosting with reverse cycle defrost that doesn't affect product characteristics
- Ventilated forced circulation ensures maximum temperature uniformity
- Storage space with gelato pans
- Thermostat: digital control for temperature accuracy
- Climate Class: 86°F/60RH%
- Gas Refrigerant: R404A
- Wheels with brake
- 3 year compressor

OPTIONS





- 5 Liter template
- Remote application
- Customize logo

Pan Sizes:
4 Liter Pan 10 1/8" x 6 1/8" x 5 7/8" (258mm x 156mm x 150mm)
5 Liter Pan 14 3/16" x 6 1/2" x 4 3/4" (360mm x 165mm x 120mm)

DERBY GELATO		
TECHNICAL FEATURES		MODEL
		DG7
External Dimensions (L-D-H)	Inches	53 15/16" - 26 1/2" - 51 3/4"
	MM	1370 - 673 - 1315
Crated Dimensions (L-D-H)	Inches	62" - 32 1/4" - 59 3/4"
	MM	1522 - 822 - 1518
5 Liter Pan capacity*	Pan Configuration	 7
Power Supply**	(V)	120V
Amperage	(A)	15A
Operating Temperature	*F	-5°F
Net Weights	Kg/Lb	135Kg / 297Lb
Crated Weights	Kg/Lb	148Kg / 325Lb

* Pans not Included

** 220V Available

DERBY PLUS GELATO			
TECHNICAL FEATURES		MODELS	
		DPG8	DPG10
External Dimensions (L-D-H)	Inches	33 7/8" - 32 1/2" - 51 3/4"	39" - 32 1/2" - 51 3/4"
	MM	860 - 826 - 1315	990 - 826 - 1315
Crated Dimensions (L-D-H)	Inches	39 3/4" - 38 1/2" - 59 3/4"	45" - 38 1/2" - 59 3/4"
	MM	1012 - 978 - 1518	1143 - 978 - 1518
4 Liter Pan capacity*	Pan Configuration	 8	 10
5 Liter Pan capacity*	Pan Configuration	 6	 7
Power Supply**	(V)	120V	120V
Amperage	(A)	15A	17A
Operating Temperature	*F	-5°F	-5°F
Net Weights	Kg/Lb	110Kgs / 242Lbs	125Kgs / 275Lbs
Crated Weights	Kg/Lb	118Kgs / 260Lbs	136Kgs / 299Lbs

* Pans not Included

** 220V Available



361-367 Beach Road, Burlingame, CA 94010
 Tel: 855.885.2400 | 650.342.2400 | Fax: 650.342.7400
 sales@oscartek.com | www.oscartek.com

